

BRODA[®]

Operating Manual

Encore Pedal Rocker



Distributor/Rep: This manual must be given to the caregiver responsible for this chair and its occupant.

Caregiver: Before using this chair, read this manual thoroughly and save for future reference.

Contents

FOREWORD.....	1
GENERAL INFORMATION.....	2
1 DEFINITIONS.....	3
2 SAFETY REQUIREMENTS.....	4
2.1 Training.....	4
2.2 Application.....	4
2.3 Shipping and Storage.....	4
2.4 Pre-Service Check.....	5
2.5 Hazards.....	5
2.5.1 Position of Chair - “Danger of Falling”.....	5
2.5.2 Position of Seat Tilt - “Danger of Tipping”.....	5
2.5.3 Location of Chair - “Danger of Tipping or Falling Objects”.....	5
2.5.4 Total Lock Wheel Brakes - “Danger of Falling”.....	5
2.5.5 Re-Positioning of Resident - “Danger of Clamping”.....	6
2.5.6 Unintended Movement - “Danger of Falling or Collision”.....	6
2.5.7 Resident Clothing - “Risk of Injury to Resident’s Skin”.....	6
2.5.8 Improper Restraint Use - “Risk of Serious Injury”.....	6
2.6 Improper Use.....	6
2.7 Cleaning.....	7
2.8 Maintenance.....	8
2.9 Resident Specific Instructions.....	9
3 OPERATION AND MOVEMENT.....	10
3.1 Rocking Function.....	10
3.2 Seat Tilt.....	10
3.3 Rocking Tension.....	11
3.4 Removable Wings.....	11
3.5 Shoulder Bolsters.....	12
3.6 Height Adjustable Armrests.....	12
3.7 Adjustable Seat Height.....	13
3.8 Casters.....	13
3.9 Mag Wheels.....	13
3.10 Footrests / Hangers (Option).....	14
3.11 Accessories (Options).....	14
4 INSPECTION AND FUNCTIONAL TESTING.....	16
4.1 Inspection.....	16
4.2 Functional Testing.....	16
5 TECHNICAL INFORMATION.....	17
5.1 Specifications.....	17
5.2 Encore Pedal Rocker Parts Schematic Drawing.....	18
6 COMMON TROUBLESHOOTING AND REPAIR.....	19
6.1 Troubleshooting for Gas Cylinders.....	19
7 WARRANTY.....	21

FOREWORD

Congratulations on your purchase of a Broda product and thank you for your confidence in our company and products.

Broda assumes a leadership role in providing optimum re-positioning functions and mobility for residents of long-term care institutions. Our chairs do not look like traditional chairs and offer advantages unique to Broda. We are sure that after using your chair, you will be convinced that your resident's quality of life will be greatly enhanced.

This manual will assist you in making the best use of the capabilities of your chair and will ensure that you quickly become familiar with its operation.

After reading this manual, if you have any questions about the safe and effective operation of your chair or accessories contact your local Broda representative or our Customer Service for further assistance.

US Sales/Customer Service:

15455 Conway Rd. Suite 200
St. Louis, MO 63017
North America Toll Free:
Phone : 844-552-7632 (BRODA)
Fax : 844-442-7632 (BRODA)

Canada Manufacturing:

560 Bingemans Centre Drive
Kitchener, Ontario Canada
N2B 3X9
North America Toll Free:
Phone : 844-552-7632 (BRODA)
Fax : 844-442-7632 (BRODA)

Email: sales@brodaseating.com

Website : www.brodaseating.com

GENERAL INFORMATION

This document provides guidance on the safe and effective operation of your Broda product.

Information in this manual must be followed at all times.

Anyone involved with the operation or maintenance of the Broda product, including the resident's family members, must read this operating manual before using the chair.

The resident's primary caregiver is responsible for ensuring that anyone who is unfamiliar with, unwilling, or unable to adhere to the safety and operating instructions, is not permitted to operate or move the chair.

A copy of this instruction manual must always be available.

Broda accepts no liability for damages, injury or accidents caused by operating errors, improper maintenance, or disregard of the instructions in this manual, including any resident specific instructions.

Broda reserves the right to make changes to the specifications, dimensions, functions, or components of its products without notice. Product representations in this manual may vary from delivered products.

Each chair has a unique identifying serial number that must be maintained on the chair as well as with any equipment records.

1 DEFINITIONS

“Broda” means Broda Inc. doing business as Broda.

“Broda chair”, “Broda product” or “chair” refers to Encore Pedal Rocker (model 48R V4)

“Long-Term Care Institution” refers to a nursing home, hospital, or other healthcare facility that provides health and personal care to its residents on a long-term basis.

“Resident” refers to an individual living in a long-term care institution or at home under the care of professional caregivers.

“Professional Caregiver” refers to doctors, nurses, therapists, nursing aids, healthcare aids, and other specialists who work in a long-term care institution and provide health and personal care to its residents.

“Caregiver” refers to any person in a long-term care institution who is appropriately trained to provide care or services to the resident or the chair used by the resident and may include the resident’s family members or guardian.

“Seat Tilt” refers to changing the relative angle between the chair’s seat and the chair frame or ground without changing the relative angle between the back and the seat.

“Transfer(s)” refers to the movement of a resident into or out of the chair with the assistance of their caregiver(s).

“Mechanical Transfer(s)” refers to the movement of a resident into or out of the chair with the assistance of their caregiver(s) using a patient lift or other assistive device that bares the weight of the resident.

2 SAFETY REQUIREMENTS

2.1 Training

Before the chair is put into service, this manual must be read thoroughly by the caregiver(s) directly responsible for the resident's care.

After the chair is put into service, this manual must be read thoroughly by any new caregivers prior to operating or moving the chair.

For the purpose of this manual, a resident's family member who shares responsibility for their care is considered a caregiver and is subject to the same competency before being permitted by the resident's primary caregiver to operate or move the chair.

Prior to first use, the customer must arrange for an in-service on the operation and safety requirements in this manual, must be given to the resident's caregivers by the local Broda representative who supplied the chair.

The primary caregiver must maintain a list of caregivers who have read this manual and who they have authorized to operate and move the chair.

The resident's primary caregiver is responsible for ensuring that anyone who is unfamiliar with, unwilling, or unable to adhere to the safety and operating instructions, is not permitted to operate or move the chair.

The operations of the chair must be performed by the resident's primary caregiver who is responsible for seating. All The operations and adjustments performed should be done in a manner to ensure the overall safety, comfort and well-being of the resident, caregiver and third party. All operations and adjustments required for the resident should be determined by the resident's primary caregiver who is responsible for seating.

2.2 Application

Broda products are intended exclusively for residents of long-term care institutions and/or who are under the care of professional caregivers. The suitability of a Broda product must be determined by a qualified caregiver who is familiar with the seating needs of the intended resident. Any other use of the chair is excluded from possible liability claims.

The Encore Pedal Rocker is not to be used in the shower. The frame and components will rust and will void the warranty.

The chairs are not explosion resistant and must not be used where there are flammable gases or liquids present (e.g., anesthetics, volatile solvents and cleaners, etc.)

Broda products are designed for use with specific Broda parts and accessories. The use of non-Broda parts or accessories with a Broda product may void the warranty and is excluded from possible liability claims.

Broda products may only be used as described in this manual and with proper regard for recognized healthcare and workplace safety and accident prevention practices.

2.3 Shipping and Storage

Broda's chairs should be shipped and stored in an upright position and not stacked higher than 3 boxes. No other materials should be shipped or stored on top of a Broda box. Broda's boxes should not be placed on pallets.

Broda's chairs should be shipped and stored at temperatures between -20°C and 40°C. Broda's chairs should not be used until they are between 0°C and 30°C.

Broda's chairs should be kept in a clean, dry environment. Do not leave Broda's chairs outdoors as it may cause the paint to peel.

Upon receipt, the shipping carton must be immediately examined for damage. Any damage should be noted on the delivery receipt and a request for inspection by the transportation company should be made. Next, the shipping carton should be opened, and the chair must be examined for concealed shipping damage. If the chair appears to be damaged, do not use the chair. File a concealed damage report with the transportation company.

2.4 Pre-Service Check

Broda's chairs are delivered fully assembled. If the chair does not appear to be ready to use upon receipt, immediately contact your supplier and do not put the chair into service until any concerns have been resolved.

Visually inspect the chair for damage, missing parts, and loose fasteners prior to testing the chair's functions. Functional testing must be successfully completed after visual inspection and before use. These obligations apply to the chair's first use and to all subsequent uses (Section 4: Inspection and Functional Testing).

2.5 Hazards

2.5.1 Position of Chair - "Danger of Falling"

After a resident is transferred into a chair, assess the amount of tilt required. We recommend that the chair's seat be tilted sufficiently to prevent the resident from sliding or falling forward off the chair. The amount of seat tilt used should be determined by the resident's caregiver who is responsible for seating.

2.5.2 Position of Seat Tilt - "Danger of Tipping"

We recommend that the chair's seat be tilted sufficiently to prevent an agitated resident from tipping the chair forward or backward, or from slumping and sliding in the chair. The amount of seat tilt used should be determined by the resident's caregiver who is responsible for seating. Always ensure that the resident is properly positioned before operating the seat tilt.

2.5.3 Location of Chair - "Danger of Tipping or Falling Objects"

We recommend that when a resident has been moved to their destination, the chair is placed where the resident cannot reach handrails or other objects, fixed or movable. This is to prevent the resident from pulling the chair over or pulling themselves off the seating surface and to prevent the resident from pulling movable objects onto the chair and themselves.

We recommend that the chair be used in a supervised area to prevent untrained residents, caregivers, or third parties from unauthorized operation, movement, or unsafe actions such as sitting or leaning on the reclined back, elevated footrest, or the armrests. These actions, if not prevented, put the chair at risk of tipping or damage to the chair.

We recommend that a chair only be located on a level surface to minimize the risk of tipping over.

2.5.4 Total Lock Wheel Brakes - "Danger of Falling"

The special casters found on Broda's chairs have total lock brakes which prevent the wheels from turning and swiveling. The brakes must always be applied when:

- 1) the chair is not in use;
- 2) a resident is being transferred (moved) into or out of the chair.

It is important to note that if the wheel brakes are applied while the resident is in the chair, that the caregiver does not leave the resident unattended, especially those residents who have the capability or tendency to move the chair and/or those who may be agitated. This could cause harm to the resident if they attempt to move the chair while the wheel brakes are applied.

Note that removing and attaching the footrest may be easier for the caregiver with the brakes applied

Failure to follow these instructions will unnecessarily increase the risk of serious falls by residents, caregivers, or third parties caused by the chair unintentionally moving.

2.5.5 Re-Positioning of Resident - “Danger of Clamping”

The Encore Pedal Rocker offers the benefits of seat tilt and height adjustable arms and rocking function. During the movement of any of these functions, the following safety measures must be observed:

- 1) The resident’s arms must be positioned on the armrests or inside the chair frame with their hands on their body or on.
- 2) Only one caregiver at a time attempts to operate the chair’s functions.
- 3) Only one chair function is operated at a time.
- 4) The residents’ and caregivers’ body are clear of all pinch points before operating the chair’s functions.

Failure to follow these safety measures can put the residents’ or caregivers’ limbs at risk of injury. Residents who may be unaware of their body position or unable to maintain a safe body position are at the most risk of the danger from clamping and caregivers should be more cautious with these residents. A second caregiver may be required to ensure the safety of these residents during these operations.

2.5.6 Unintended Movement - “Danger of Falling or Collision”

We recommend Broda’s chairs for indoor use within a long-term care institution, home or acute care institution, where there is not enough slope to cause the chairs to move unaided. Chairs used where the surface is uneven or sloped are at risk of unintended movement and could become a serious danger to the resident, caregiver(s), or a third party. We recommend that Broda’s chairs are located away from stairwells, elevators, and exterior doorways within a long-term care institution.

Outdoor use is appropriate only under the strict supervision and full attention of a caregiver who is physically capable of preventing any unintended movement over any surfaces that are to be traveled on. We recommend that a second caregiver assist when the chair is moved over surfaces that could cause significant unintended movement.

2.5.7 Resident Clothing - “Risk of Injury to Resident’s Skin”

We recommend that residents only be seated while they are fully dressed in clothing that meets the needs of their specific condition. If after being fully dressed, a resident’s bare arms, legs, or body could still come into direct contact with the vinyl straps or vinyl pads, we recommend the use of a covering, such our terry cloth or vinyl covered seat and/or back pad or a folded cloth bed sheet to prevent direct contact. Direct contact of bare skin on the straps over a period of time could cause moisture on the resident, and/or cause the skin to stick to the straps. Prior to the operation or movement of a chair with a covering, the caregiver must ensure any covering placed on the chair does not come into contact with any moving parts and is securely placed, so not to slip.

2.5.8 Improper Restraint Use - “Risk of Serious Injury”

We recommend that alternatives to physical restraints be used with residents while seated in the chair except under the specific instructions of the resident’s primary caregiver and with permission of the resident’s family or guardian. Physical restraints have been identified as a common cause of serious injury to residents while they are seated. We recommend that the primary caregiver responsible for seating first consider the re-positioning options available in the chair to reduce the risks of sliding, falling, or self-injury.

If a physical restraint is determined to be appropriate to prevent sliding or falling out of the chair, we recommend that Broda’s Thigh Belt be used. In all cases, it is the resident’s primary caregiver that must take responsibility for the safety of the resident if restraints are used.

2.6 Improper Use

As outlined, the improper use of the chair is dangerous to the resident, caregivers, or third parties, and can consist of, but is not limited to the following:

- 1) Unauthorized operation of the chair’s functions.
- 2) Unauthorized movement of the chair.
- 3) Inappropriate use of the chair for a resident who has not been assessed by a qualified caregiver responsible for their seating.

- 4) Failure to frequently reposition the resident in the chair
- 5) Attempting to operate of multiple chair functions simultaneously by one or more caregivers.
- 6) Attempting to move the chair with the brake(s) applied.
- 7) Leaving the resident unattended in the chair near other objects.
- 8) Leaving an agitated resident in the chair in an unsupervised area.
- 9) Leaving a resident unattended.
- 10) Leaving a resident in a chair on a sloping surface.
- 11) Leaving a chair unattended on a sloping surface.
- 12) Using non-Broda accessories on the chair.
- 13) Using the chair at temperatures below 0°C.
- 14) Using the chair as a shower or bathing chair.
- 15) Using the chair for any use other than its intended purpose.

2.7 Cleaning

Broda's chairs should be wiped clean with soap and water. Diluted household strength ammonia or chlorine based cleaner, as well as a hospital grade cleaner may be used if necessary.

Refer to the following guide for cleaning certain staining agents (Applies to the Permablok3® vinyl, as per the vinyl manufacturer's recommendations) The frame and components of the chair can be cleaned using the same procedure as the vinyl.

The steps below are also located in the Cleaning Guide found on the back of the chair

Staining Agent	Cleaning Procedure
Eye Shadow / Mascara	Step 1
Grease / Suntan Lotion / Chocolate	Step 1
Blood / Bodily Fluids	Step 2
Red Lipstick	Step 2
Oil Base Paint / Tar / Asphalt	Step 3
Other Tough Stains	Step 4 or 5*

Step 1: Remove excess spill with a damp cloth. Clean with a 1:1 mix of Ivory® liquid and water. Rinse with clean water and dry.

Step 2: Use a straight application of concentrated cleaners such as Formula 409® or Fantastik® Spray Cleaner. Then wipe with a clean cloth. If using a hospital grade cleaner, follow the diluting instructions on the label.

Step 3: Use a 1:1 mix of ammonia and water or a 1:4 mix of bleach and water. Rinse with clean water and dry.

Step 4: Use a straight application of naphtha (lighter fluid). Rinse thoroughly with clean water and pat surface dry.

Step 5: Use a 1:1 mix of isopropyl alcohol and water. If the stain persists, use straight alcohol. Rinse thoroughly with clean water and pat dry. If the stain remains, use a 1:1 mix of acetone and water. Rinse with clean water and pat surface dry.

***Note:** for cleaning that requires steps 4 or 5 – Use a soft cotton cloth saturated with the cleaning material and rub the stain in circles 10 times. Pat dry with another soft cotton cloth and check results.

For best cleaning results, certain parts and padding on the chair should be removed: Instructions for removal of the following parts are in this manual: Ensure that the entire chair including removable and non-removable parts is thoroughly cleaned.

Pay close attention to the frame, sockets, fasteners, parts and casters, as well as the padding for an even, thorough clean.

Remove parts for cleaning if desired:

- 1) Wings

3) Footrests

4) Padding

Thoroughly clean all removable parts and padding, as well as the frame and components around the parts and padding that have been removed.

Broda's chairs should not be cleaned with petroleum-based cleaners. Any petroleum-based products that come in contact with any vinyl surface should be removed as quickly as possible. Petroleum based products make vinyl brittle and will damage the seating surface and cushions. Metal parts and cushions should be wiped completely dry after cleaning. Do not launder vinyl padding. Terry seat and back covers can be laundered and tumble dried.

Do not allow the chair to air dry. Leaving the chair to air dry and not ensuring the entire chair is completely dry may cause the frame and components to rust. Solvents such as those found in spray lubricants should not be used on Broda's chairs as they can damage moving parts.

Frequency and method of cleaning the chairs should be determined by facility infection control protocols. If visibly soiled, thoroughly clean the chair immediately as per the cleaning instructions in this manual.

The cleaning instructions in this manual are guidelines only. Results may vary under actual conditions. The information does not relieve the user of proper and safe use of the product and all cleaning agents and consideration for the overall cleaning maintenance of the chair. Cleaning and care instructions must be followed in conjunction with facility infection control protocols.

Broda will not accept warranty or liability claims on chairs that have not been cleaned according to the instructions or cared for in proper regard for patient, caregiver and third-party safety and hygiene. The use of certain agents may be harmful to the surface appearance and lifespan of the vinyl. Broda assumes no responsibility resulting from the use of such cleaning agents to the vinyl.

Touch up paint is available for the powder coated frame. Please call Broda's Customer Service if touch up paint is required. Do not leave Broda's chairs outdoors as the frame is not UV protected. Leaving the chairs outdoors could cause the paint to peel.

Formula 409® is a trademark of the Clorox Company.

Fantastik™® is a trademark of DowBrands, Inc.

Trademark of the Dow Chemical Company.

Ivory® is a trademark of Proctor and Gamble.

2.8 Maintenance

The maintenance on the Encore Pedal Rocker will vary with the amount of use and the condition of the resident using the chair.

In regular use, after the initial inspection and functional testing, the chair should be inspected and tested bimonthly. We recommend visually inspecting for signs of wear, damage, loose or missing fasteners, and other safety concerns. Periodic testing of chair functions is also necessary. If a breakage, defect, or operational problem is detected, the chair must be successfully repaired, inspected and tested for function before it is returned to service.

The chair should be inspected and tested as often as each use if the chair is used by:

- 1) Aggressive or agitated residents.
- 2) Residents who have involuntary movements.
- 3) Residents weighing over 220 lbs.
- 4) A facility with irregular or sloped surfaces.
- 5) Any unauthorized person.

Do not use lubricants that contain solvents. Solvents may compromise any rubber components on the chair. If necessary, white food grade grease or lubricant can be used on any sliding components.

2.9 Resident Specific Instructions

The primary caregiver responsible for the specific resident’s seating shall add additional instructions necessary for the safe and effective use of the chair based on their professional experience and knowledge of the resident’s specific conditions and requirements.

Broda representatives are not professional caregivers and will not know the specific requirements of the individual using the chair. Broda relies on the knowledge, experience, and judgment of the resident’s professional caregiver to ensure the specific resident’s safety and comfort needs are satisfied while using the chair.

These instructions form an essential part of the Safety Requirements for using the chair and must be made available to all caregivers. Space is provided below to include these instructions.

Broda Inc.
North America Toll Free: 844-552-7632 (BRODA)
Fax: 844-442-7632 (BRODA)
Email: sales@brodaseating.com
Website: www.brodaseating.com

3 OPERATION AND MOVEMENT

Safety measures as described in Section 1 must be observed when operating the chair's functions or moving the chair. Only authorized caregivers should attempt to operate or move a chair. The caregiver must use proper body mechanics when operating the chair and be prepared to support the weight of the resident while operating the chair.

3.1 Rocking Function

The Encore Pedal Rocker has a rocking function that helps to calm agitated residents. The rocking function has a lock that is activated or deactivated by the caregiver. The rocking can be used independently or in conjunction with tilt for a deeper tilt angle. (See instructions- Seat Tilt)

To Activate Rocking:

- Ensure the seat is in an upright or slightly tilted position. (See instructions- Seat Tilt)
- Squeeze and lock the rock handle by securing it to the frame.
- Adjust the rocking tension according to resident in the chair. (See instruction- Rocking Tension)**

To deactivate rocking:

- Release the rock handle from the frame.
- WARNING: DO NOT place hand near cable housing on handle as this could cause pinching.**
- Let the seat engage in the desired position. To engage in the most upright position, the seat may need to be lifted slightly to guide into position.



3.2 Seat Tilt

Gas cylinders allow the seat to be tilted to any position from most upright to the lowest within its range. Use seat tilt to safely position the resident, redistribute pressure and increase comfort. The Encore Pedal Rocker seat tilt is designed to allow for foot propulsion while tilted.

To Activate the Seat Tilt:

- Place hand on the bar to assist movement and squeeze the tilt handle with other hand.
- Raise or lower the seat tilt until the desired angle is achieved.

Both the tilt and rocking functions can be used together to achieve a deeper seat tilt by tilting first, then activating the rocking mechanism.



3.3 Rocking Tension

The rocking tension can be adjusted to accommodate residents of various weights. For ease of rocking, the rocking tension should be:

- decreased for lighter occupants.
- increased for heavier occupants.

For residents with rigid movements, the rocking tension may need to be increased accordingly to their rocking force.

To adjust rocking tension:

To decrease tension (lighter occupants) turn the knob clockwise.

To increase tension, (heavier occupants) turn the knob counter-clockwise.

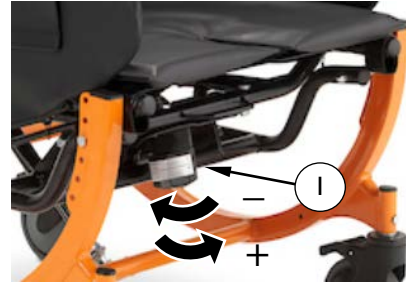

3.4 Removable Wings

Wings support the Shoulder Bolsters which provide upper body lateral support. The wings are width and height adjustable to accommodate various residents.

To Remove the Wing:

-Loosen the knob (1) and pull the wing from the receptacle.

To Insert the Wing:

- Insert the wing back into the receptacle. Tighten the knob (1) and ensure the wing is secured in place.

To Adjust the Wing Height:

-Loosen the knob (2) and raise or lower the wing to the desired position.

-Tighten the knob (2) and ensure the wing is secured in place.

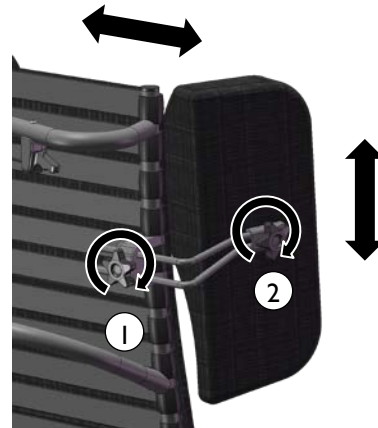

3.5 Shoulder Bolsters

The Shoulder Bolsters provide upper torso support, protection and containment and accommodate asymmetries in the chair user. Their unique design allows for proper elbow access to the arm rest. The Shoulder Bolster is always used in conjunction with the side wing.

To Attach the Shoulder Bolsters:

- Fit the Shoulder Bolster over the wing.
- Secure with the Velcro strips.

Note: The Shoulder Bolster can be inverted on the wing to provide support to narrower residents.

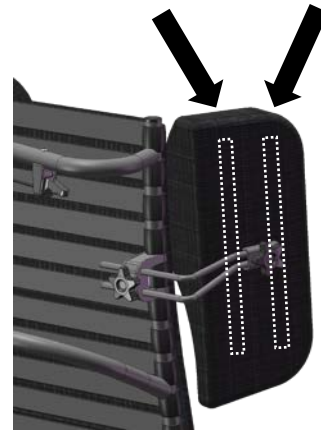

3.6 Height Adjustable Armrests

The armrest height can easily be adjusted to accommodate various residents. The armrest height should be adjusted to provide correct arm support for the resident as determined by the caregiver.

To Adjust the Armrest Height:

- Squeeze the pins together which are located under the armrest flap.

WARNING: DO NOT place fingers at the top of the pins as this could cause pinching. Place fingers in the concave shape of the pins.

- Raise or lower the arm to the desired height.

WARNING: DO NOT place fingers anywhere underneath the arm while adjusting, as this could cause pinching. Upon releasing the pins, the armrest height will lock into place.

Secure the outside flap on the side panel.

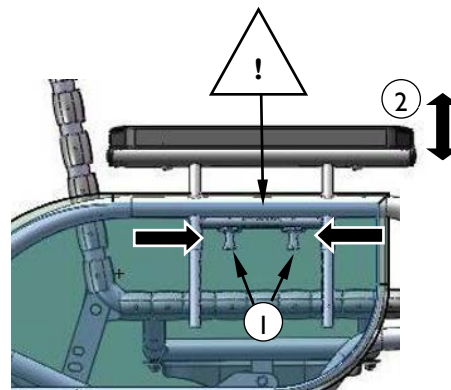

3.7 Adjustable Seat Height

The seat to floor height is adjustable to allow for proper “foot on floor” position for foot propulsion.

To Adjust the Seat Height:

- Using 7/16 wrenches, remove the bolts at the front of the seat.
- Raise or lower the front of the seat to correspond with the holes at the desired seat height.
- Insert the bolts through the desired corresponding holes and tighten the bolts.

If desired, adjust the hole position of the tilt cylinder to correspond with the opposite hole position of the front of the seat to maintain the original range of tilt. Adjusting the hole position of the tilt cylinder can also allow for deeper initial posterior tilt or achieving anterior tilt depending on the hole position of the tilt cylinder relative to the seat height.

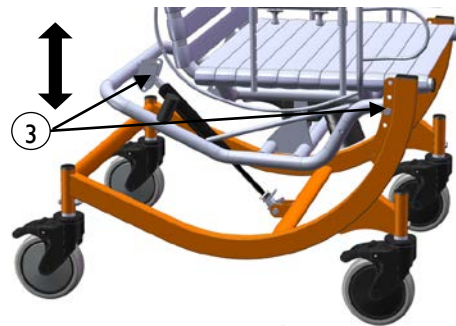
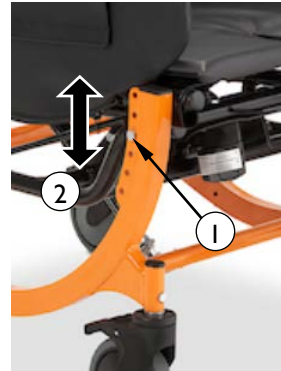

3.8 Casters

The Encore Pedal Rocker features 5” total lock front casters and 5” fixed rear casters.

To Operate the Casters:

Step on/off the caster pedal to lock/unlock the caster.

Always ensure the brakes are not locked when wheeling the chair.



3.9 Mag Wheels

The Encore Pedal Rocker offers optional front mounted mag wheels

To Operate the Mag Wheels:

Pull to the wheel lock lever to engage the brake on the mag wheel

Push the wheel lock lever to disengage the brake on the mag wheel.

Always ensure the brakes are not locked when wheeling the chair.



The mag wheels feature 3 mounting positions for forward adjustment to accommodate individual needs for stability and maneuverability.

To Adjust the Fore-Aft Position of the Mag Wheel:

Remove the bolts that attach the mag wheels to the mag wheel mounting plate

Move the mag wheels to the desired position along the mag wheel mounting plate and re-insert the bolts in the desired position. (Furthest forward is the most stable position) Upper 3 holes are used for 22" mag wheels, Lower 3 holes are used for 20" mag wheels. Ensure the bolts are tightened.

Move the wheel locks fore-aft, depending on the mag wheel position, in order to provide proper contact with the mag wheels for locking the wheels. Ensure wheel lock bolts are tightened and wheel locks securely attached.

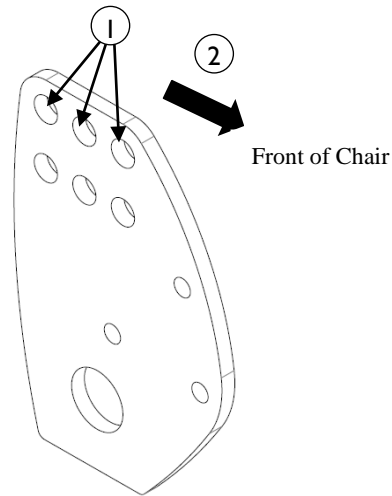

3.10 Footrests / Footrest Hangers (Option)

Swing away footrests and elevating swing away legrests are available options for the Encore Pedal Rocker

To Install Footrests/Legrests:

Insert the upper bracket of the footrest/legrest into the upper receptacle of the hanger.

Line up the lower footrest bracket to the lower receptacle on the hanger latch block.

Push down on footrest/legrest and swing in/out the footrest/legrest to lock into place. Ensure footrest is locked in place.

To Remove Footrests/Legrests:

Squeeze the footrest/legrest handle while swinging in/out the footrest/legrest

Lift footrest/legrest from hanger to release.

To Install Legrest Hangers:

Insert the legrest hanger into the bracket underneath the front of the seat to the desired depth.

Insert the 2 bolts provided into the holes underneath the bracket through the hanger and secure using 3/16" Allen key and 1/2" wrench. Make sure bolts are tightened.

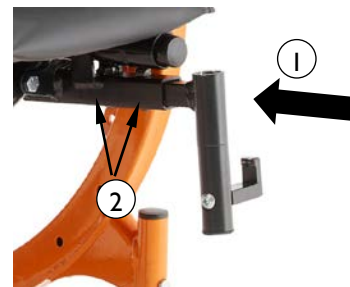

To Remove Legrest Hangers:

Remove the 2 bolts from underneath the bracket to which the hangers are installed using 3/16" Allen key and 1/2" wrench.

Remove the hangers from the bracket.

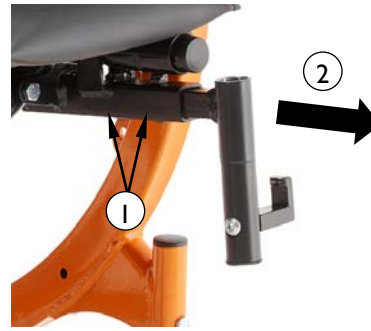

3.11 Accessories (Options)

We recommend Broda accessories for use only on Broda's chairs. The correct installation of Broda's accessories is very important. We recommend that the chair is ordered with the required accessories already installed. Only authorized caregivers who thoroughly understand the accessory installation procedures should attempt to install their Broda accessories without assistance from their local Broda representative. Broda does accept liability for non-Broda supplied parts used on our chairs.

4 INSPECTION AND FUNCTIONAL TESTING

Safety measures as described in Section 1 must be observed when inspecting or testing a chair. Only authorized caregivers or maintenance staff should attempt to inspect or test a chair.

4.1 Inspection

We recommend regular visual inspection for signs of wear, damage, loose or missing fittings, and other safety concerns. If a breakage, defect, or operational problem is detected, the chair must be repaired inspected and tested for function before it is returned to service.

We recommend that the chair be inspected as often as each use if there is any reason to be concerned about the possibility of increased wear or loose or missing fittings. **At a minimum, in regular use the chair should be inspected on a bimonthly basis.** The visual inspection procedure should include at least the observation of all the fittings (fasteners):

The visual inspection procedure should include at least the observation of the following parts:

- 1) The cylinders that position the seat tilt
- 2) The vinyl straps used in the seat and back
- 3) The cushions
- 4) The black handles and cables
- 5) The armrest height adjustment pins
- 6) The adjustable rocking tension mechanism
- 7) The rocking plunger
- 8) The casters and wheels

The visual inspection procedure should include the observation of any installed accessories. The visual inspection should be performed by the facility, or if in a private residence, by the individual responsible for the chair.

4.2 Functional Testing

We recommend that the chair should be tested for operation of the chair's functions without a resident in the chair. The testing may be as often as each use if there is any reason to be concerned about the possibility of increased wear or damage to the chair's components. At a minimum, in regular use the chair should be tested for functions as described in Section 3.

If the caregiver or maintenance department performing the functional testing believes that any function is not operating correctly, the chair should be taken out of service until a satisfactory functional test can be completed.

The caregiver or maintenance department performing the testing should be aware that the seat tilt will be more difficult without a resident in the chair. When performing repairs or maintenance, do not use lubricants that contain solvents. Solvents will damage many of the moving components in the chair. If necessary, a white, food grade grease (lubricant) may be used on the sliding components in the chair. Do not use spray lubricants on any part of the chair.

5 TECHNICAL INFORMATION

5.1 Specifications

Specifications Based on 20" Wide Encore Pedal Rocker Standard Features

The Encore Pedal Rocker is available with either standard (tall) back length with wings, or with short back option.

1. Seat Tilt: Up to 18° of seat tilt (infinitely adjustable), Up to 33 ° of infinitely adjustable seat tilt when combined with rocking function.
2. Rocking Function Provides gentle rocking while user is seated in the chair.
Rocking has caregiver lock to activate or deactivate
Rocking tension can be adjusted according to the weight of the individual in the chair.
3. Frame: 16-gauge powder coated tubular steel
4. Seat/Back Surface: Comfort Tension Seating® Strapping is 1.5" wide, by .130" thick; contains fungicide, has shape memory retention, is fire retardant
5. Arms: Adjustable armrest height
6. Padding: Standard removable padding – Neckrest, Shoulder Bolsters, (standard/tall back), Seat and Back Pad, Lower Side Pads, Apron
The 34-ounce healthcare vinyl fabric covering is manufactured to meet the following requirements: DIN 75 200/DIN 53 438; MVSS 302, M2;CAL 117, and Wyzenbeck Heavy Duty Abrasion Test; has an antimicrobial, antibacterial, anti-stain and anti-static finish; Cold crack of -20°C. Polyurethane foam meets CAL 117-2013.

Removable seat and back pads are covered with an 8-ounce soft vinyl which meets CAN2-162 flammability standard for hospital textiles. Polyurethane foam meets CAL 117-2013. Removable, washable, pre-shrunk fitted cotton terry covers are provided for the seat and back pads. Terry covers provide absorption, and vapor and heat transfer.
7. Casters: 5" total lock front casters, 5" fixed rear casters
8. Seat Depth: 17" (18.5" also standard)
9. Seat Height: Adjustable 14" – 19" (1" increments)
10. Seat Width: 20" (18" also standard)
11. Overall Width: 25"
12. Weight Capacity: 250 lbs
13. Overall Weight: Approx. 80 lbs standard features

All dimensions are ± 0.5".

5.2 Encore Pedal Rocker Parts Schematic Drawing

Coming Soon:

Please contact Broda at 1-844-552-7632 or inquiries@brodaseating.com
for specific parts inquiries for your Encore Pedal Rocker

6 COMMON TROUBLESHOOTING AND REPAIR

Please have the chair serial number ready when contacting BRODA or your local area representative for parts or assistance for your chair. The serial number can be found on a grey sticker on the rear of the chair.

6.1 Troubleshooting for Gas Cylinders

The use of gas charged springs (cylinders) on BRODA products allows the caregiver to easily make adjustments to the tilt, recline, and leg rest with a minimal effort. The gas cylinders contain Nitrogen gas, it is not flammable nor is it toxic. The cylinders provide a lifting force which counterbalances the weight of the occupant thereby reducing the amount of weight the caregiver needs to lift.

Symptom	Problem	Solution
The chair is not tilting when the handle is squeezed	The pin in the end of the cylinder is not being depressed when the handle is pulled.	Ensure the cable is attached to the cylinder actuator. If cable is attached, see Adjustment Steps below.
The chair (tilt) seems to slowly slide out of position	The pin in the end of the cylinder may be still partially depressed.	See Adjustment Steps below:

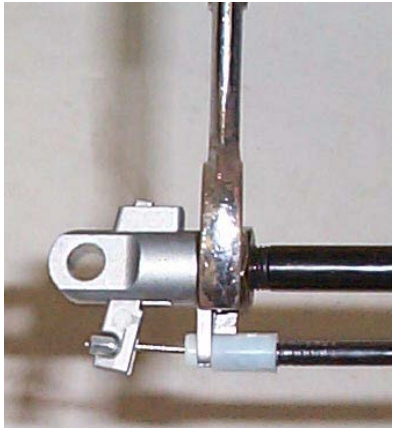
Adjustment Steps:	
<ul style="list-style-type: none"> -Loosen the lock nut located on the stem of the gas cylinder next to the actuator (17mm or 11/16" wrench) -From the above instruction determine whether you want to wind the stem further into the actuator or further out of the actuator. Wind the stem further into the actuator if the chair is not tilting or reclining, (wind clockwise) and wind it further out of the actuator if the chair is slowly sliding out of position. (wind counter-clockwise) -Wind the stem in the correct direction one half turn. It should be tightened enough so that the lever is not too loose or too tight. -Check the function of the cylinder and repeat the above step until the cylinder functions properly. -Tighten the lock nut loosened in the first step. -If adjusting the cylinder does not correct the problem, the cylinder may need to be replaced. Please contact Broda or your local area representative. 	 <p>Note: Cylinder does not need to be removed from the chair to make this adjustment.</p>

Note: When adjusting cylinders with tools that come in contact with the cylinder rods, a cloth or some other protective material must be used to protect the sliding surface of the rod. If the rod becomes scratched or marred it will damage the seal on the cylinder and the cylinder will fail.

Damaging a cylinder in this fashion voids the manufacturer's warranty.

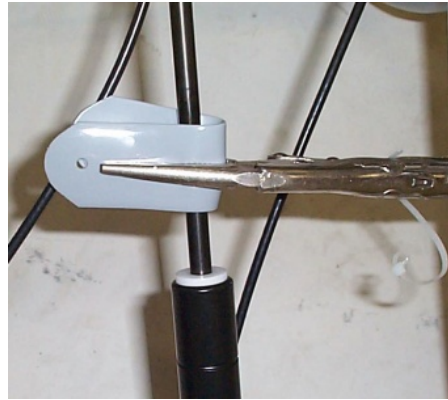

7 WARRANTY

Broda® LP
(Subsidiary of MITY, Inc.) Phone: (844) 552-7632
1301 West 400 North, Orem Utah, 84057 Fax: (844) 442-7632

Effective 10/1/2016

From date of purchase Broda warrants the side frames and cross members located on the base frame, for the Lifetime* of the original purchaser/user, when purchased from an Authorized Broda Provider. In addition, Broda warrants its product, except the seat cushion and covers (which are not warranted), to be free from defects in materials and workmanship for a period of one (1) year from the date of purchase, as indicated on the original purchase order. This warranty is non-transferable.

*Expected Lifetime of frame is 7 years.

The warranty is subject to the following conditions:

A serial number or invoice number is required for warranty coverage. The warranty shall not apply to serial numbered items if the serial number has been removed or altered in any way.

Warranty is valid for “new” purchases only. All other items will be warranted at the sole discretion of Broda.

If within such warranty period any such product shall be proven to be defective through examination, inspection and testing as deemed necessary, such product shall be repaired or replaced at Broda’s discretion. This warranty does not include on-site labor.

On request, defective parts must be returned to the factory, pre-paid and insured, within thirty days. Failure to do so, will result in the owner incurring the cost of the replacement parts. Photos of defective parts may be requested as an alternate to returning product.

Limitations and Exclusions:

This warranty does not cover damages that arise from improper handling, cleaning, maintenance, storage or negligent use. The warranty does not cover Broda chairs used in any way, other than the manner in which it was designed and recommended.

Modifications, incorrect assembly or installation to Broda products or the use of non-Broda products voids the warranty. Installation of parts that require the frame to be altered in any way, must be completed by a Broda Representative, unauthorized performances will void the warranty. This warranty does not cover freight damage (see Damaged Freight Policy).

Broda retains the right to make product design and product application changes without notice.

The application of Broda products shall remain the responsibility of the purchaser or user. Please reference the model specific operating instruction manuals for safety requirements, inspectional and functional testing, technical information and more.

WC-19 Transportation packages

Vehicle Transport Options are available factory installed only. It can NOT be retrofit to existing models or serviced in the field. All components of the vehicle transport packages are subject to specific maintenance requirements, to maintain the Broda warranty.

Due to the testing requirements of the vehicle transport chair, Broda warranty limitations apply to non-factory installed repairs. Warranty and maintenance repairs must be made by Broda authorized service technicians. Any replacements or repairs made by unauthorized person(s) will void this warranty and Broda assumes no liability on the performance of said components.

DO NOT modify the transport chair. Modifications may change the transport chair’s structure and center of balance, which may increase the risk of serious injury to the user and void the warranty.

If a problem is detected with any of the Vehicle Transport Option components or any components of the chair, remove the chair from service and contact Broda immediately.

Chairs involved in vehicle accidents should be taken out of use immediately.

**For any further questions regarding Warranty Information please contact
Broda Customer Service at 1-844-552-7632 or customerservice@brodaseating.com**